

TECHNICAL DATASHEET

PowerValue 11 RT G2

1-10 kVA



PowerValue 11 RT G2
1-3 kVA



PowerValue 11 RT G2
6-10 kVA

Classification IEC/EN 62040-3
VFI-SS-111

Working mode
on-line double conversion

Module power rating
1-10 kVA

Paralleling
up to 3 units (only 6-10 kVA)

Output power factor
1.0

Efficiency double conversion
up to 95%

Efficiency in ECO-MODE
up to 98%

Maximum weight w/out batteries
15.0 kg

Input current distortion THDi
<3 %

Input power factor (PF)
≥ 0.995

Communication cards
SNMP / Modbus / AS400

Mechanical configuration
Rack-Tower with rotatable display



- Up to 9 battery modules per UPS can be added
- Rotatable display (90°)

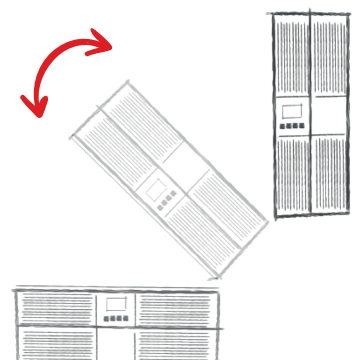
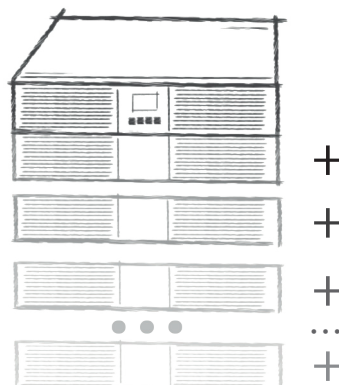

About this manual

Document information

File name	:	4NWD002979_TDS_ABB_PVA11_1-10kVA-RT_EN_REV-G
UPS model	:	PowerValue 11 RT G2 1-3 kVA
Date of issue	:	27.02.2020
Issued by	:	Product Marketing
Checked by	:	R&D
Article number	:	N/A
Document number	:	4NWD002979
Revision	:	G

Contents

UPS features	4
Frequency conversion	4
Cold start.	4
Automatic load start-up.	4
Paralleling	4
Emergency power off (EPO)	5
Fan speed control	5
Wide input voltage and frequency range	5
Design flexibility	5
Generator compatibility.	5
Increasing the runtime	5
Batteries	6
UPS battery type	6
External battery type module	6
Battery autonomy	6
Rear view	7
1 kVA B, 1 kVA S	7
2 kVA B, 2 kVA S	7
3 kVA B	7
3 kVA S	7
6-10 kVA	7
Connectors / sockets	8
Options	9
Rack mounting kits	9
Network interface card	9
Supported models	9
Sensors	9
Relay interface card	9
Models	9
External maintenance bypass with PDU	9
ATS 16A	9
Monitoring software	9
Technical specifications	10
General data.	10
Input characteristics	11
Output characteristics	12
Double conversion efficiency in normal mode, linear load	12
Bypass automatic: Static switch	12
Battery characteristics	13
User interface – Communication	13
Clearances	14
Heat dissipation	14
Cable & fuse	15

UPS features



Frequency conversion

Operating as a frequency converter, PowerValue 11 RT G2 not only converts the power supply frequency (50 Hz to/from 60Hz), but it also protects the load from power disturbances and guarantees additional battery power in case of mains failure.

The operation and installation is simple and implies in correctly wiring the UPS and in selecting the frequency conversion mode in the LCD display.

- Input frequency range:
 - 1-3kVA: 45-66Hz
 - 6-10kVA: 40-70Hz
- Output frequency: 50 or 60 Hz
- Output de-rating:
 - 1-3kVA: 60%
 - 6-10kVA: 80%

Cold start

PowerValue 11 RT G2 can be started without being connected to the mains power supply (start up from the batteries).

This feature is specially useful in the following situations:

- To start up and operate the unit even throughout a power outage.
- To help identify, during an unsuccessful system start-up, if the malfunction is on the power supply. Eg. If the UPS starts-up on battery and does not transfer to online or bypass mode, it is most probable that there is a mains failure.

Automatic load start-up

After a power outage, the UPS transfers to battery. If the batteries are completely discharged and the system shuts down, with the automatic load start up feature, the UPS will restart automatically once the mains power is recovered.

The operator can enable, disable or configure this function through the LCD panel according to the following options:

- UPS will charge the batteries and the inverter will start automatically
- UPS will charge the batteries and start immediately on bypass. In this case, the operator has to start the inverter manually.
- UPS will charge the batteries and no output power will be seen either on bypass or on inverter. In this case, the operator has to start the inverter manually.

Paralleling

PowerValue 11 RT G2 6 and 10 kVA UPSs can be installed in parallel to increase the total system power or to add redundancy to the system. The UPSs are delivered with an in-built parallel board and paralleling cables. No additional hardware is required for this installation.

Emergency power off (EPO)

Activating the emergency power off control of the UPS, the AC and the DC sources to the load are entirely disconnected.

Operation: To recover the UPS's normal status, the EPO connector has to be set back to its original configuration (Normally closed through a jumper in the UPS rear panel). After this, the EPO status has to be cleared through the LCD menu and the UPS will recover its operation in bypass-mode.

To transfer the UPS to normal-mode, the selection has to be made through the LCD display.

Fan speed control

The speed of PowerValue 11 RT G2 fans vary with the load level and with the ambient temperature to minimize the power consumption while keeping the UPS in a safe working temperature.

Wide input voltage and frequency range

With higher input tolerances, the UPS works longer on bypass or normal mode. This helps reducing the consumption of the batteries when there are small variations in the power supply.

Design flexibility

PowerValue 11 RT G2 is extremely compact and is designed to be positioned in a tower format or rack-mounted. The display is rotatable (1-3kVA electronically, 6-10kVA mechanically) and therefore easy adjustable to your configuration needs.

Generator compatibility

Generators power are often routed through the UPS to supply power to the load during long power outages. The UPS acts as a power link that keeps critical systems operational until the generator synchronises with the UPS and picks up the load. With PowerValue 11 RT G2, the power of the generator should be dimensioned 1.3 times the UPS rated power.

Increasing the runtime

Battery modules are available to increase the system runtime.

The cables for connecting the battery modules to the UPS are integrated to the units and these can be easily plugged together to increase the system's runtime. To connect several battery modules to a group of UPSs in parallel (only for 6-10kVA), the battery modules should be firstly connected to each UPS. Only after this procedure is done, the UPSs should be connected in parallel. Long backup models are available in the range 1-3 kVA with max. 6A battery charger integrated in the UPS (no internal batteries). The battery charger current is self adjusted by the UPS in function of the external battery system capacity. The 6-10 kVA UPS provides an adjustable battery charger current (up to 12A) for ease of operations demanding long backup.







Batteries



PowerValue can be configured with matching battery modules to satisfy extended runtime demands. Easily replaceable batteries increase availability and reduce Mean Time to Repair (MTTR).



UPS BATTERY TYPE

	Power (kVA)	Internal batteries	Charging current
	1 kVA B	1 x 2 x 9.4Ah	1.5A
	1 kVA S	–	max. 6A
	2 kVA B	1 x 4 x 9.4Ah	1.5A
	2 kVA S	–	max. 6A
	3 kVA B	1 x 6 x 9.4Ah	1.5A
	3 kVA S	–	max. 6A
	6 kVA	–	0-12A (default: 4A)
	10 kVA	–	0-12A (default: 4A)

EXTERNAL BATTERY TYPE MODULE

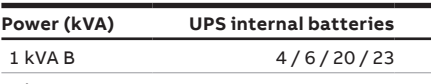
	Power (kVA)	Dimensions (WxHxD) [mm]	Weight [kg]	Battery
	1 kVA B	438x86.2x309.8	17.92 kg	(2 x 2) x 9.4Ah
	1 kVA S	438x86.2x309.8	17.92 kg	(2 x 2) x 9.4Ah
	2 kVA B	438x86.2x426.5	31.32 kg	(2 x 4) x 9.4Ah
	2 kVA S	438x86.2x426.5	31.32 kg	(2 x 4) x 9.4Ah
	3 kVA B	438x86.2x629.8	44.90 kg	(2 x 6) x 9.4Ah
	3 kVA S	438x86.2x629.8	44.90 kg	(2 x 6) x 9.4Ah
	6 kVA	438x129x592	62.1 kg	(1 x 20) x 9Ah
	10 kVA	438x129x592	62.1 kg	(1 x 20) x 9Ah

BATTERY AUTONOMY

Power (kVA)	UPS internal batteries	UPS + 1 batt module	UPS + 2 batt module	UPS + 3 batt module	UPS + 4 batt module
1 kVA B	4 / 6 / 20 / 23	21 / 30 / 48 / 104	40 / 55 / 86 / 179	59 / 81 / 124 / 255	79 / 106 / 162 / 331
1 kVA S	–	12 / 18 / 29 / 66	30 / 42 / 67 / 141	49 / 73 / 105 / 217	69 / 94 / 143 / 293
2 kVA B	4 / 6 / 11 / 23	21 / 30 / 49 / 105	40 / 56 / 87 / 181	60 / 82 / 126 / 258	80 / 108 / 164 / 335
2 kVA S	–	12 / 18 / 30 / 68	31 / 44 / 69 / 145	50 / 70 / 108 / 222	70 / 96 / 147 / 300
3 kVA B	4 / 6 / 11 / 24	22 / 31 / 50 / 108	42 / 57 / 89 / 186	61 / 84 / 129 / 264	82 / 99 / 168 / 343
3 kVA S	–	13 / 19 / 32 / 72	32 / 45 / 72 / 152	51 / 72 / 112 / 233	72 / 98 / 152 / 315
6 kVA	–	7 / 10 / 18 / 49	18 / 28 / 49 / 133	33 / 49 / 88 / >180	49 / 75 / 133 / >180
10 kVA	–	3 / 5 / 9 / 24	9 / 13 / 24 / 64	16 / 24 / 43 / 115	24 / 36 / 64 / 173

Battery autonomy in minutes at 100 / 75 / 50 / 25% load

Given runtimes are estimates and valid at 20 degrees Celsius. Actual runtime of the system will depend, among many variables, on the age of the batteries and environmental conditions

Rear view

1 KVA B, 1 KVA S

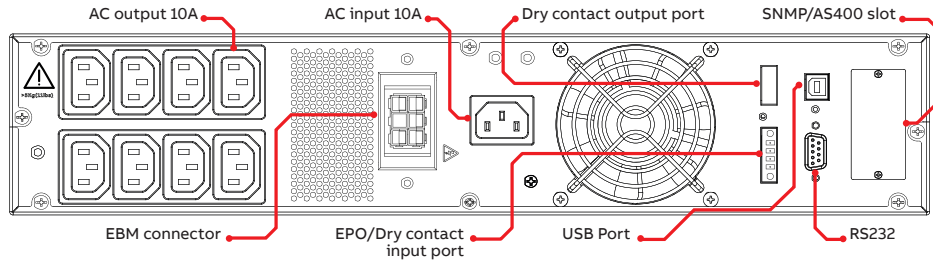

2 KVA B, 2 KVA S

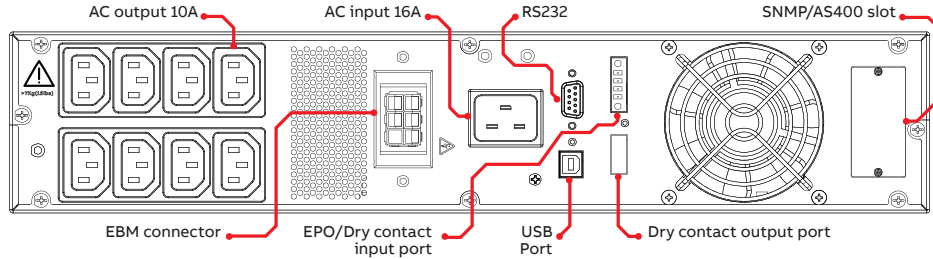

3 KVA B

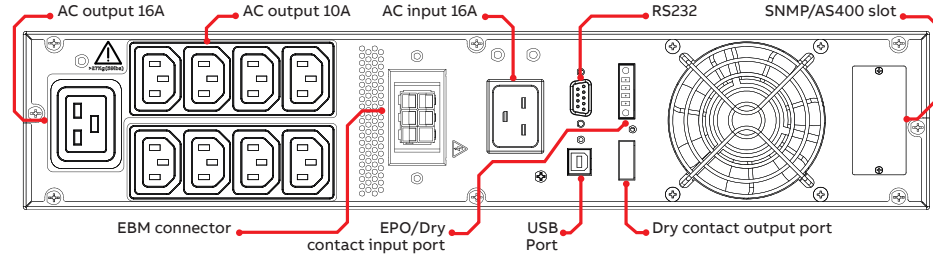



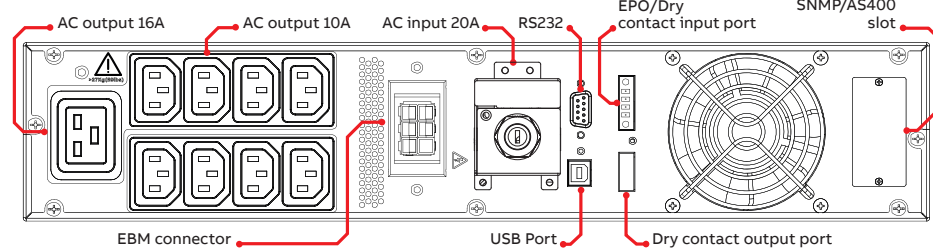



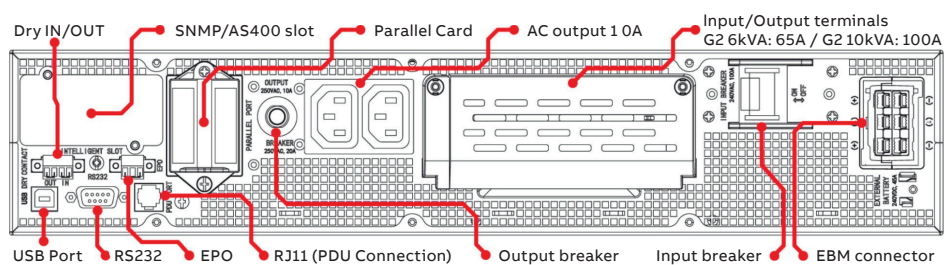









3 KVA S



6-10 KVA



CONNECTORS / SOCKETS

Product name	Output socket				Input socket			
	Qty	Type	Current	Drawing	Qty	Type	Current	Drawing
1 kVA B 1 kVA S	8	IEC-320C13	10 A		1	IEC-320C14	10 A	
2 kVA B 2 kVA S	8	IEC-320C13	10 A		1	IEC-320C20	16 A	
3 kVA B	8	IEC-320C13	10 A		1	IEC-320C20	16 A	
	1	IEC-320C19	16 A					
3 kVA S	8	IEC-320C13	10 A		1	Terminals Cable gland	20 A	
	1	IEC-320C19	16 A					
6 kVA	2	IEC-320C13	10 A		1	Terminal Blocks	65 A	
	1	Terminal Blocks	65 A					
10 kVA	2	IEC-320C13	10 A		1	Terminal Blocks	100 A	
	1	Terminal Blocks	100 A					

Options

For 1-3 kVA, an external enclosure is necessary to connect via RS232 to the UPS.

RACK MOUNTING KITS

Rack rails, screws and metallic plates for easy installation of the UPS and EBM's to a standard 19' rack.

NETWORK INTERFACE CARD

Enables real-time monitoring of your UPS system via a standard web browser or by using the included monitoring software.

ABB's monitoring devices provide real-time visibility of the condition of your power equipment and help in solving problems before they become critical.

SUPPORTED MODELS

- WebPro SNMP (1-3kVA)
- WebPro ModBus (1-3kVA)
- Winpower SNMP (6-10kVA)
- Winpower Modbus (for 6-10kVA only RS485)
- Environmental Monitoring Probe

Third party adapters can be installed as well¹:

- CS141 slot / box Basic
- CS141 slot / box Advanced
- CS141 slot / box ModBus



SENSORS

Temperature sensors, humidity sensors and alarm buzzers support monitoring the environmental condition and enables an efficient identification of the alarms.

RELAY INTERFACE CARD

Provides contact closures for remote monitoring of alarm conditions of PowerValue 11 RT G2 systems.

The card is user-installable, hot-swappable and enables advanced communication between the UPS and the computer

Models

- AS400

EXTERNAL MAINTENANCE BYPASS WITH PDU

It provides maintenance bypass capability plus serves as an output Power Distribution Unit; it allows service continuity during UPS maintenance or upgrade with no load interruptions. Two models are available, respectively for 1-3 kVA and 6-10 kVA.



ATS 16A

The ATS-16 is a two-way, single-phase, automatic switch powered by two independent synchronous or asynchronous AC power supply sources (typically two feeding UPSs upstream). One of the two sources can be designated as the preferred power supply, to which the ATS-16 will transfer the load. The ATS-16 promptly switches to the other source in the event of primary source failure. The external maintenance bypass with PDU delivers a maintenance bypass feature and convenient power distribution. This enables the user to service the UPS in a safe and proper manner by excluding any risk for the operator while the load is powered by the AC mains. Easy to install in a rack-mount (1RU only) or vertical configuration, the ATS-16 has an intuitive interface with LED indicators and push buttons. The ATS-16 enhances the system reliability due to internal back-feed protection and complete protection for overload and short-circuit.

MONITORING SOFTWARE

It is an advanced UPS management software suite to allow remote control and monitoring of UPS equipped with network interface cards in a LAN or Internet environment. It can manage a single or multiple UPSs and prevent data loss from power outage by programming a safe system shutdown. The software is included with the SNMP adapter.

Technical specifications

GENERAL DATA	1 kVA (B/S)	2 kVA (B/S)	3 kVA (B/S)	G2 6 kVA	G2 10 kVA
Photograph					
Apparent power	1 kVA	2 kVA	3 kVA	6 kVA	10 kVA
Active power	1 kW	2 kW	3 kW	6 kW	10 kW
UPS type	On-line, transformer-free	On-line, transformer-free	On-line, transformer-free	On-line, transformer-free	On-line, transformer-free
Parallel capability	No	No	No	Up to 3 frames	Up to 3 frames
Battery	Included (B) Not included (S)	Included (B) Not included (S)	Included (B) Not included (S)	Not included	Not included
Performance classification	VFI-SS-111	VFI-SS-111	VFI-SS-111	VFI-SS-111	VFI-SS-111
MECHANICAL					
Dimensions (width×height×depth) [mm]	438 x 86.2 x 309.8	438 x 86.2 x 426.5	438 x 86.2x 629.8	438 x 86.5 x 573	438 x 86.5 x 573
Weight (with batteries)	11.4kg (B), 5.8kg (S)	19.1kg (B), 8.7kg (S)	27.9kg (B), 9.0 kg (S)	13.1 kg	15.0 kg
ACOUSTIC NOISE (acc. To IEC 62040-3)					
In normal mode (at <=25°C) at 100 / 50 % Load	<45 dBA	<50 dBA	<50 dBA	<50 dBA	<50 dBA
In battery mode (at <=25°C) at 100 / 50 % Load	<45 dBA	<50 dBA	<50 dBA	<50 dBA	<50 dBA
SAFETY					
Access	Operator	Operator	Operator	Operator	Operator
Degree of protection against hazards and water ingress	IP 20	IP 20	IP 20	IP 20	IP 20
ELECTROMAGNETIC COMPATIBILITY					
Compliant to IEC 62040-2	Yes	Yes	Yes	Yes	Yes
Category Emission / Immunity	C2	C2	C2	C3	C3
ENVIRONMENTAL					
Storage temperature range	-15°C – +60°C	-15°C – +60°C	-15°C – +60°C	-15°C – +60°C	-15°C – +60°C
Operative temperature range	0°C – +40°C	0°C – +40°C	0°C – +40°C	0°C – +40°C	0°C – +40°C
Storage (models with batteries)	0°C – +35°C	0°C – +35°C	0°C – +35°C	0°C – +35°C	0°C – +35°C
Relative humidity	≤ 95% (non-condensing)			≤ 95% (non-condensing)	
Max. altitude without de-rating	1000m (above 1000m, 1% de-rating every 100m according to IEC/EN 62040-3)				
ADDITIONAL AND USUAL INFORMATION					
Input connection	3 wires, 1 phase + N + PE			3 wires, 1 phase + N + PE	
Output connection	3 wires, 1 phase + N + PE			3 wires, 1 phase + N + PE	
Cable entry	Rear	Rear	Rear	Rear	Rear
Battery cable entry	Rear	Rear	Rear	Rear	Rear
Accessibility	Front only	Front only	Front only	Front only	Front only
Air outlet	Rear	Rear	Rear	Rear	Rear
OPTIONS					
Environmental monitoring probe					
External battery modules (EBM)					
Network interface cards/box					
Relay card with potential-free contacts (customer outputs)					
External maintenance bypass with PDU					
ATS 16 A (for 1-3 kVA only)					
Rack mounting kits for UPS and EBM					
ModBus card					
INCLUDED (DEFAULT)					
Parallel Kit (parallel board pre-installed, parallel cable provided with each unit)	N/A	N/A	N/A	Included	Included
Sea freight packaging (carton box)	Included	Included	Included	Included	Included
Back-feed protection	Internal	Internal	Internal	See manual	See manual

INPUT CHARACTERISTICS	1 kVA (B/S)	2 kVA (B/S)	3 kVA (B/S)	G2 6 kVA	G2 10 kVA
Rated voltage (steady-state, r.m.s)	120-300VAC (de-rating to 60% at 120V)	120-300VAC (de-rating to 60% at 120V)	120-300VAC (de-rating to 60% at 120V)	100-276 VAC (de-rating to 50% at 100V)	100-276 VAC (de-rating to 50% at 100V)
Nominal voltage	208 VAC / 220 VAC / 230 VAC / 240 VAC	208 VAC / 220 VAC / 230 VAC / 240 VAC	208 VAC / 220 VAC / 230 VAC / 240 VAC	208 VAC / 220 VAC / 230 VAC / 240 VAC	208 VAC / 220 VAC / 230 VAC / 240 VAC
Tolerance, referred to 230V	-22% / +30% at <100% load, -31% / +30% at <80% load, -41% / +30% at <70% load, -48% / +30% at <60% load	-22% / +30% at <100% load, -31% / +30% at <80% load, -41% / +30% at <70% load, -48% / +30% at <60% load	-22% / +30% at <100% load, -31% / +30% at <80% load, -41% / +30% at <70% load, -48% / +30% at <60% load	-23% / +20% at <100% load, -33% / +20% at <80% load, -43% / +20% at <60% load, -48% / +20% at <40% load	-23% / +20% at <100% load, -33% / +20% at <80% load, -43% / +20% at <60% load, -48% / +20% at <40% load
Frequency, rated	50 Hz / 60 Hz (selectable)	50 Hz / 60 Hz (selectable)	50 Hz / 60 Hz (selectable)	50 Hz / 60 Hz (selectable)	50 Hz / 60 Hz (selectable)
Frequency tolerance	45 Hz – 55 Hz (50 Hz system) / 54 Hz – 66 Hz (60 Hz system)	45 Hz – 55 Hz (50 Hz system) / 54 Hz – 66 Hz (60 Hz system)	45 Hz – 55 Hz (50 Hz system) / 54 Hz – 66 Hz (60 Hz system)	45 Hz – 55 Hz (50 Hz system) / 54 Hz – 66 Hz (60 Hz system) Extendable to 40 Hz – 70 Hz at load <60%	45 Hz – 55 Hz (50 Hz system) / 54 Hz – 66 Hz (60 Hz system) Extendable to 40 Hz – 70 Hz at load <60%
Current (r.m.s), rated (with battery charged and input 230V)	4.9 A	9.6 A	14.2 A	27.5 A	45.8 A
Current (r.m.s), maximum (with charging batt. and input 230V)	5.2 A (B) 5.9 A (S)	10.2 A (B) 11.4 A (S)	15.0 A (B) 16.9 A (S)	39.5 A	57.8 A
Total harmonic distortion (THDi)	< 5 % @ 100% linear load	< 5 % @ 100% linear load	< 5 % @ 100% linear load	<3% @ 100% linear load	<3% @ 100% linear load
Power factor	≥ 0.99 @ 100% load	≥ 0.99 @ 100% load	≥ 0.99 @ 100% load	≥ 0.995 @ 100% load	≥ 0.995 @ 100% load
Rated short-time withstand current (I _{cw})	3 kA for 1.5 cycles	3 kA for 1.5 cycles	3 kA for 1.5 cycles	6 kA for 1.5 cycles	6 kA for 1.5 cycles
AC power distribution system	TN-C, TN-C-S, TN-S, TT			TN-S, IT	
Phases required	1	1	1	1	1
Neutral required	Yes	Yes	Yes	Yes	Yes
Connection	3 wires, 1 phase + N + PE			3 wires, 1 phase + N + PE	
Cable entry	Rear	Rear	Rear	Rear	Rear
Walk In/Soft Start	Yes (Power supply needed only for first start-up)			Yes (Power supply needed only for first start-up)	

OUTPUT CHARACTERISTICS	1 kVA (B/S)	2 kVA (B/S)	3 kVA (B/S)	G2 6 kVA	G2 10 kVA
Rated power	1 kW	2 kW	3 kW	6 kW	10 kW
AC power distribution system	TN-C, TN-C-S, TN-S, TT			TN-S, IT	
Available phases	1	1	1	1	1
Neutral available	Yes	Yes	Yes	Yes	Yes
Rated voltage (steady state, r.m.s.)	208 / 220 / 230 / 240 V AC (no de-rating)	208 / 220 / 230 / 240 V AC (no de-rating)	208 / 220 / 230 / 240 V AC (no de-rating)	208 / 220 / 230 / 240 V AC (no de-rating)	208 / 220 / 230 / 240 V AC (no de-rating)
Variation in normal mode / battery mode	± 1%	± 1%	± 1%	± 1%	± 1%
Total Harmonic Distortion (THDu), 100% Load, Normal Mode					
- Linear	< 2%	< 2%	< 2%	< 1%	< 1%
- Non-linear (acc. to IEC 62040-3)	< 5%	< 5%	< 5%	< 5%	< 5%
Total Harmonic Distortion (THDu), 100% Load, Battery Mode					
- Linear	< 2%	< 2%	< 2%	< 1%	< 1%
- Non-linear (acc. to IEC 62040-3)	< 5%	< 5%	< 5%	< 5%	< 5%
Voltage Transient And Recovery Time, 100% Step Load					
- Linear	20 ms	20 ms	20 ms	20 ms	20 ms
- Non-linear (acc. to IEC 62040-3)	100 ms	100 ms	100 ms	100 ms	100 ms
Transfer time normal mode --> battery mode	0 ms	0 ms	0 ms	0 ms	0 ms
Frequency (steady-state), rated	Synchronized with the input mains: 45-55 Hz for 50 Hz systems 54-66 Hz for 60 Hz systems Range adjustable in 50/60 Hz +/- 4 Hz				
Variation in free-running	± 0.1 Hz	± 0.1 Hz	± 0.1 Hz	± 0.1 Hz	± 0.1 Hz
Max synch phase error (referred to a 360° cycle)	≤3°	≤3°	≤3°	≤3°	≤3°
Max slew-rate	1 Hz/s	1 Hz/s	1 Hz/s	1 Hz/s	1 Hz/s
Nominal current (In), r.m.s. rated	4.5 A	9 A	13 A	26.1 A	43.5 A
Overload on inverter (line mode)	300ms: > 150% load, 10s: 130-150% load, 60s: 105-129% load, continuous:100-104% load.			500ms: > 150% load, 20s: 125-150% load, 10m: 100-124% load.	
Fault clearing capability normal mode and battery mode (100ms) *default	2.0 x In	2.0 x In	2.0 x In	3 x In	3 x In
Crest factor (Load supported)	3 : 1	3 : 1	3 : 1	3 : 1	3 : 1
Load power factor, rated	1.0	1.0	1.0	1.0	1.0
Displacement (permissible lead-lag range)	0.5 lead – 0.5 lag	0.5 lead – 0.5 lag	0.5 lead – 0.5 lag	0.5 lead – 0.5 lag	0.5 lead – 0.5 lag

DOUBLE CONVERSION EFFICIENCY IN NORMAL MODE, LINEAR LOAD

100% load	89%	91%	92%	94.1%	94.2%
75% load	87.7%	88.2%	91.6%	94.9%	94.7%
50% load	84.6%	86.5%	90.6%	95.0%	95.1%
25% load	76.2%	80.6%	88.8%	94.0%	94.3%
Eco-mode efficiency, linear load	≥97.5%	≥98%	≥98%	≥98%	≥98%

BYPASS—AUTOMATIC: STATIC SWITCH

Transfer time: inverter to bypass / bypass to inverter / inverter to eco-mode / eco-mode to inv.	<8 ms / <8 ms / <8 ms / <8 ms	<8 ms / <8 ms / <8 ms / <8 ms	<8 ms / <8 ms / <8 ms / <8 ms	<4 ms / <4 ms / <4 ms / <10 ms	<4 ms / <4 ms / <4 ms / <10 ms
Fault clearing capability (bypass mode) for 20 ms	26.6 x In ¹ (120A)	22.2 x In ¹ (200A)	15.3 x In ¹ (200A)	15.3 x In ¹ (400A)	13.3 x In ¹ (580A)
Overload on bypass mode	300ms: >180% load, 60s: 130-180 % load, continuous: 101-129% load.			500ms: >150% load, 30s: 125-150% load, continuous: <125% load.	
Bypass - maintenance	Optional, external	Optional, external	Optional, external	Optional, external	Optional, external
Bypass protection fuse or circuit breaker rating	External fusing according to section Cables and Fuses				

*In (4s) if default is disabled (6-10k only)

¹ With recommended fuses, see section Cables and Fuses

BATTERY CHARACTERISTICS	1 kVA (B/S)	2 kVA (B/S)	3 kVA (B/S)	G2 6 kVA	G2 10 kVA
Technology	VRLA, vented lead-acid	VRLA, vented lead-acid	VRLA, vented lead-acid	VRLA, vented lead-acid	VRLA, vented lead-acid
Number of 12 V blocks (fixed)	2 (B) – (S)	4 (B) – (S)	6 (B) – (S)	–	–
Battery charger max. current capability	1.5 A (B) 6A (S)	1.5 A (B) 6A (S)	1.5 A (B) 6A (S)	0-12A Adjustable (4A default)	0-12A Adjustable (4A default)
Battery charger max. power capability	36 W (B) 144 W (S)	72 W (B) 288 W (S)	108 W (B) 432 W (S)	3355 W	3355 W
Floating voltage (VRLA)	2.275 VDC/cell	2.275 VDC/cell	2.275 VDC/cell	2.275 VDC/cell	2.275 VDC/cell
End of discharge voltage (VRLA)	10.7V/pcs, 0~30% Load 10.2V/pcs, 30%~70% Load 9.6V/pcs, >70% Load	10.7V/pcs, 0~30% Load 10.2V/pcs, 30%~70% Load 9.6V/pcs, >70% Load	10.7V/pcs, 0~30% Load 10.2V/pcs, 30%~70% Load 9.6V/pcs, >70% Load	Load dependent ~1.6 VDC/cell	Load dependent ~1.6 VDC/cell
Temperature compensation	Yes	Yes	Yes	Yes	Yes
Battery test	Automatic and periodic battery test (selectable)	Automatic and periodic battery test (selectable)	Automatic and periodic battery test (selectable)	Automatic and periodic battery test (selectable)	Automatic and periodic battery test (selectable)

USER INTERFACE – COMMUNICATION

RS232 on Sub-D9 port	For service and for CS141 box
Connectivity slot	For integration of optional connectivity and relay card
Display	LCD display
EPO	Emergency Power Off
Dry IN/OUT contacts	Yes
USB (monitoring software, HID)	Yes

CLEARANCES	1 kVA (B/S)	2 kVA (B/S)	3 kVA (B/S)	G2 6 kVA	G2 10 kVA
MINIMUM CLEARANCES FOR SINGLE UPS					
A	25 cm	25 cm	25 cm	50 cm	50 cm
B	0 cm	0 cm	0 cm	0 cm	0 cm
C	25 cm	25 cm	25 cm	50 cm	50 cm
D	0 cm	0 cm	0 cm	0 cm	0 cm
MINIMUM CLEARANCES FOR UPS PLUS OTHER CABINETS IN ROW					
A	25 cm	25 cm	25 cm	50 cm	50 cm
B	0 cm	0 cm	0 cm	0 cm	0 cm
C	25 cm	25 cm	25 cm	50 cm	50 cm
D	0 cm	0 cm	0 cm	0 cm	0 cm

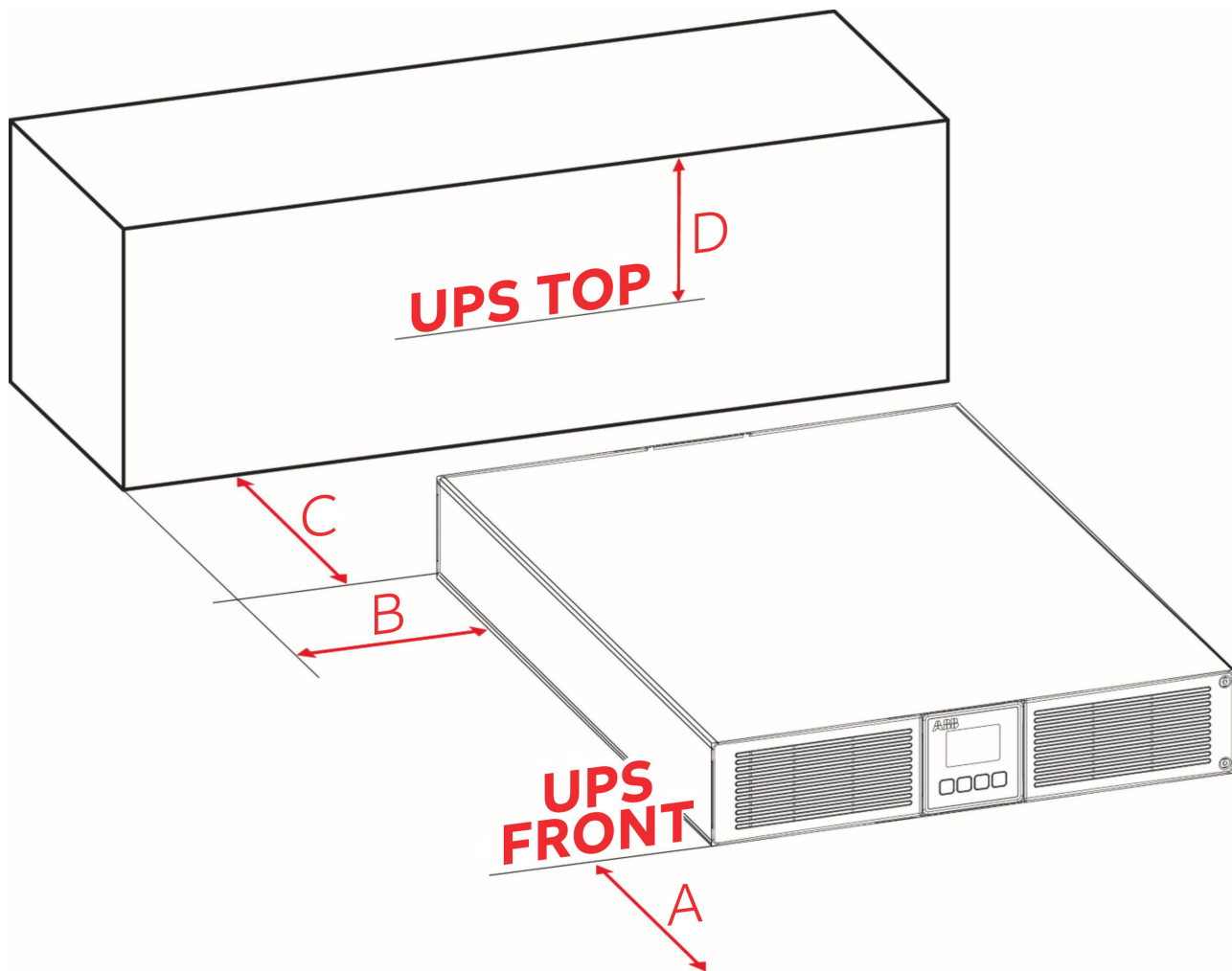

HEAT DISSIPATION	1 kVA (B/S)	2 kVA (B/S)	3 kVA (B/S)	G2 6 kVA	G2 10 kVA
Air-flow	From front to back	From front to back	From front to back	From front to back	From front to back
Heat dissipation with 100% linear load	165 W	290 W	410 W	376 W	627 W
Heat dissipation with 100% non-lin. load (acc. to 62040-3)	165 W	290 W	410 W	376 W	627 W
Air-flow (25° - 30°) with 100% non-linear load	18.000 m ³ /h	34.285 m ³ /h	37.000 m ³ /h	75.000 m ³ /h	125.000 m ³ /h
Heat Dissipation without load	43 W	50 W	57 W	70 W	100 W

CABLE & FUSE

Cable sections and fuse ratings recommended according to (IEC 60950-1)

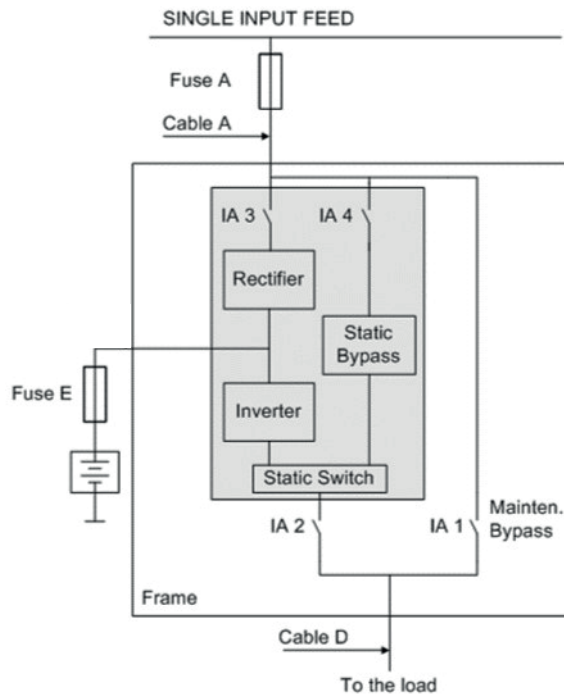

RATINGS	1 kVA (B/S)	2 kVA (B/S)	3 kVA (B/S)	G2 6 kVA	G2 10 kVA
Input fuse A-Type: gL or CB	1 x 10 A	1 x 16 A	1 x 20 A	1 x 63 A	1 x 80 A
Input cable A	3 x 0.75 mm ²	3 x 1.5 mm ²	3 x 1.5 mm ² for 3kVA B 3 x 2.5 mm ² for 3kVA S	3 x 10 mm ²	3 x 16 mm ²
Output cable D	3 x 0.75 mm ²	3 x 1.5 mm ²	3 x 1.5 mm ² for 3kVA B 3 x 1.5 mm ² and 3 x 2.5 mm ² for 3kVA S	3 x 10 mm ²	3 x 16 mm ²
Battery fuse E-Type: gR or CB	2 x 30 A	2 x 30 A	2 x 30 A	2 x 63 A	2 x 80 A

—
www.abb.com/ups
ups.sales@ch.abb.com

